

ceramic blade (Bit) Trimmer cross-recess PH000

Item No. 1-764

Trimmer for easy and safe setting of spindle resistances and potentiometers (Poti)

Specification

blade length 20 mm

blade Ø 3 mm

blade PH 000

material zirconium oxide, technical ceramic

antimagnetic

length 32 mm

weight 1 g

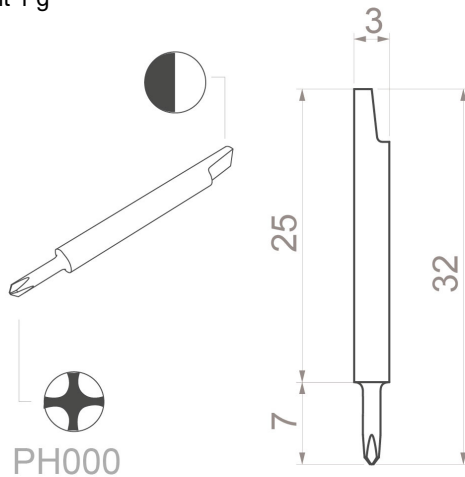

Application and technology

Adjustment tools for the ESD area. Ceramic bits meet the highest requirements due to their excellent mechanical, thermal properties. The hardness and breaking strength of zirconium oxide enable the manufacture and use of even the smallest dimensions with the greatest possible wear resistance. Adjustment tools in use, a variety of electrical and electronic equipment or assemblies must be aligned or adjusted after the manufacturing process. Even when installing new components or when electrical values have changed due to aging, an adjustment is usually necessary to restore the optimal device function. For the different application areas we offer adjustment tools made of different materials. In the field of ceramics, we manufacture not only many standard blades but also special shapes on customer request. Contact us and we will assist you with the implementation of your ideas.

Zirconium oxide is a highly wear-resistant ceramic (zirconium), tetragonal ZrO₂, Y₂O₃, partially stabilized. Physical properties at room temperature: flexural strength 800N/mm², modulus of elasticity 2x10⁵N/mm², density 6.05g/cm³, hardness 1350HV, application range up to 800°C, coefficient of thermal expansion 10x10⁻⁶ K⁻¹, thermal conductivity 2W/mK, electrical resistance insulated.