

ceramic adjusting screwdriver Trimmer slot blade 1.5x0.3x20 mm

Item No. 1-853

Trimmer for easy and safe setting of spindle resistances and potentiometers (Poti)

Specification

ESD handle with rotating cap dissipative between 10^6 and 10^9 ohm

blade length 20 mm

blade \varnothing 3 mm

blade width 1.5 mm

blade thickness 0.3 mm

material zirconium oxide, technical ceramic

antimagnetic

length 100 mm

weight 10 g

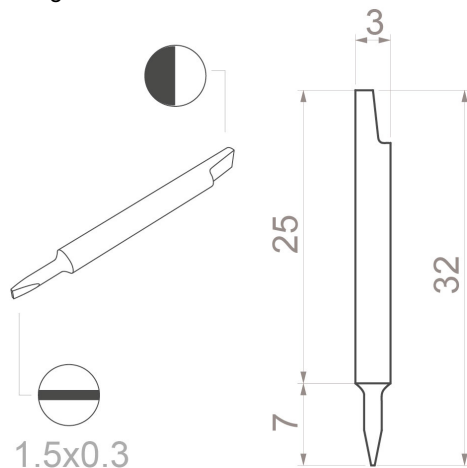

Application and technology

Adjustment tools for the ESD area. Ceramic bits meet the highest requirements due to their excellent mechanical, thermal properties. The hardness and breaking strength of zirconium oxide enable the manufacture and use of even the smallest dimensions with the greatest possible wear resistance. Adjustment tools in use, a variety of electrical and electronic equipment or assemblies must be aligned or adjusted after the manufacturing process. Even when installing new components or when electrical values have changed due to aging, an adjustment is usually necessary to restore the optimal device function. For the different application areas we offer adjustment tools made of different materials. In the field of ceramics, we manufacture not only many standard blades but also special shapes on customer request. Contact us and we will assist you with the implementation of your ideas.

Zirconium oxide is a highly wear-resistant ceramic (zirconium), tetragonal ZrO_2 , Y_2O_3 , partially stabilized. Physical properties at room temperature: flexural strength $800N/mm^2$, modulus of elasticity $2x10^5N/mm^2$, density $6.05g/cm^3$, hardness 1350HV, application range up to $800^\circ C$, coefficient of thermal expansion $10x10^{-6} K^{-1}$, thermal conductivity $2W/mK$, electrical resistance insulated.

1-753 ceramic blade (Bit) slot blade 1.5x0.3x32 mm