

ESD grip tweezers 145 mm Form 64 stainless steel long hollow Ø 5 × 10 mm dissipative

Art.-No.	5-006-7-13
Description	ESD grip tweezers 145 mm Form 64 stainless steel long hollow Ø 5 × 10 mm dissipative
Application	Gripping, holding and positioning tweezers, receptacle for geometrically shaped parts (pick-and-place)
Specification	with groove (gripping recess)
Material	stainless steel
Surface/Coating	ESD powder coated
Features	stainless, antimagnetic, acid-resistant, dissipative
Surface resistance	10 ⁶ to 10 ⁹ Ohm
Shape	DG: Geometric tips with diameter, straight
Icon No.	DG3

Dimensions and weight

A = 13.5 mm
B = 5.3 mm
Ai = 25 mm
Ø = 5 mm

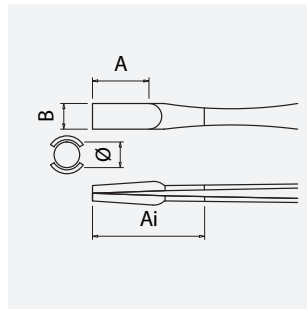

length 145 mm
weight 23 g

Application and technical data

Tweezers for SMD/THT technology, for gripping cylindrical components and components Mini MELFs, diodes, resistors, or simple holding of wires. For easy pulling and inserting of round or cubic components, bulbous or long-hollow receptacles are suitable.

100% stainless steel anti-magnetic, rust and acid resistant, non-reflective matt fine polished. Stainless austenitic chromium nickel quality steel with low carbon content, for good corrosion resistance (not seawater resistant). Dissipative black ESD coating achieves surface leakage resistance of 10⁶ to 10⁹ ohm.